

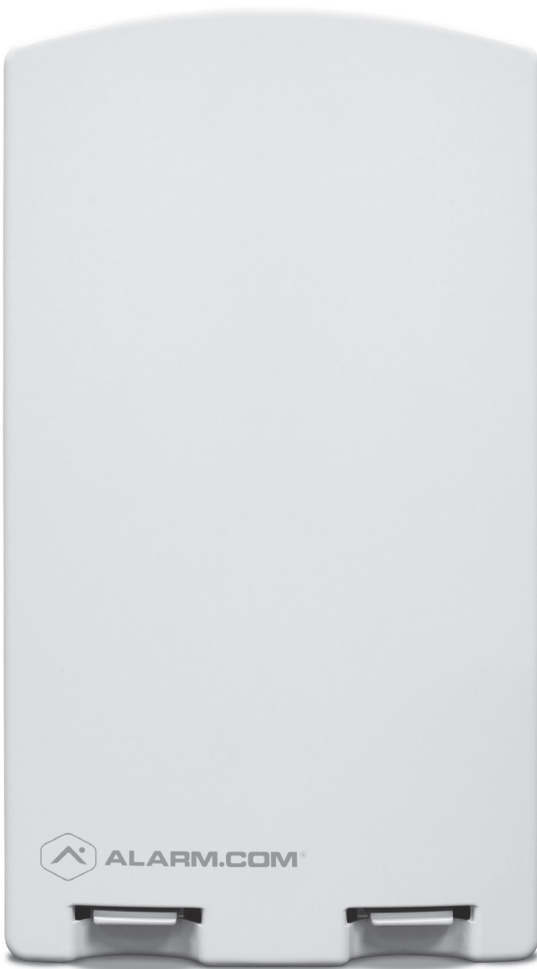

SYSTEM ENHANCEMENT MODULE

Honeywell/ADEMCO VISTA®

INSTALLATION GUIDE



INSTALL WIZARD AVAILABLE AT [ALARM.COM/SEMVISTA](https://www.alarm.com/semvista)

OVERVIEW

The System Enhancement Module (SEM) can be used with Honeywell/ADEMCO VISTA-10P, VISTA-15P, and VISTA-20P panels to enable wireless reporting of alarms and other system events using the CDMA, HSPA, or LTE wireless (cellular) network. The SEM is intended to be used as the primary communication path for all alarm signaling to the central monitoring station. The wireless alarm signaling and routing service is operated by Alarm.com. The SEM also features integrated support for Alarm.com's home automation services with built-in Z-Wave capabilities.

EQUIPMENT

SYSTEM ENHANCEMENT MODULE

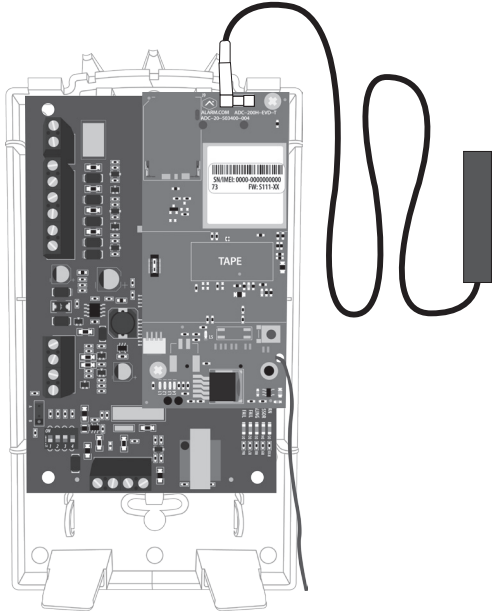

WIRE AND FUSE

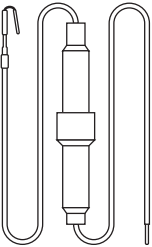

SCREWS

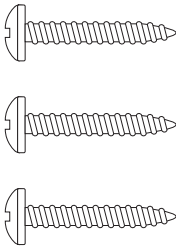

WALL ANCHORS

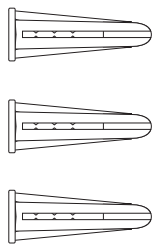

TOOLS AND SUPPLIES NEEDED

- Small blade screwdriver and Phillips screwdriver
- Drill and bits for screws and/or wall anchors
- Four-conductor, 22-gauge or larger stranded wire
- Alpha keypad (recommended for install)

TABLE OF CONTENTS

Step 1: Verify Panel Compatibility	4
Step 2: Create An Account	5
Step 3: Enable Keypad Address	6
Step 4: Disconnect Power From Panel	7
Step 5: Mount the SEM	8
Step 6: Wire the SEM to the VISTA Panel	9
Step 7: Power Up the Panel	10
Step 8: Manage User Codes	11

Add & Delete Z-Wave Devices	12
Touchscreen Keypads.....	15
Panel Settings.....	16
LEDs	17
FAQs	20
Troubleshooting.....	21
Specifications.....	22
Regulatory Information	23
SEM Quick Tips (SWIM).....	24

STEP 1: VERIFY PANEL COMPATIBILITY

The SEM is compatible with Honeywell/ADEMCO VISTA 10P, 15P, and 20P panels and the equivalents below, dating back to 2005. The date will be printed on the chip inside the panel as shown below.

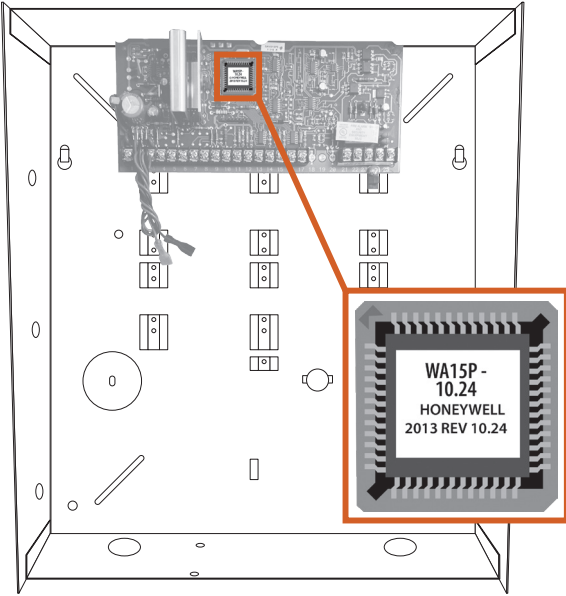

Honeywell
ADEMCO VISTA-10P

Honeywell/ADEMCO VISTA-10PSIA
First Alert FA130CP
First Alert FA130CPSIA

Honeywell
ADEMCO VISTA-15P

Honeywell/ADEMCO VISTA-15PSIA
First Alert FA148CP
First Alert FA148CPSIA

Honeywell
ADEMCO VISTA-20P

Honeywell/ADEMCO VISTA-20PSIA
First Alert FA168CPS
First Alert FA168CPSSIA



The SEM is not compatible with POTS. The SEM should be the only communication path for alarm signaling to the central station.

Please see the Alarm.com Dealer Website Support Resources page (www.alarm.com/dealer) for the most up to date list of compatible panels.

TOUCHSCREEN KEYPADS

Touchscreen keypad compatibility details can be found on page 15.



Some system changes will not be processed by Alarm.com unless the touchscreen keypad is used in Console Mode.

STEP 2: CREATE AN ACCOUNT

Before installing the SEM, first create a new Alarm.com customer account.

We recommend creating the account at least 24 hours prior to installation. This will ensure that the SEM is activated prior to installation. To create an account go to the Alarm.com Dealer Website or MobileTech and login. You will need the following information to create the account:

- Customer Address
- Customer Phone Number
- Customer E-mail
- Preferred Login Name for the Customer
- Alarm.com Module Serial Number
- Existing Panel Installer Code

During **Step 4** of the "Create New Customer" process, you will be prompted to enter the the **current Installer Code** on the panel. Alarm.com will use this code to access panel programming and read information stored on the panel. The customer will be assigned a randomly generated Master User Code. This will be displayed on the Dealer Website and also on the Customer Website after SEM installation is complete.

Home Customers Dealer Account Support & Sales ADC * System * ★ ↻

★ Create New Customer (Step 4: System Information)

Coverage Summary (Based on Installation Address) show

Please verify coverage above, then enter Control Panel and Alarm.com module information into the fields below.

* Control Panel Type: [?] SEM - Honeywell/ADEMCO Vista ▾

* Module Serial #: [?]

→ * Existing Installer Code: [?] 4112

* Master User Code: [?] 2324

< BACK NEXT >

At the end of the "Create New Customer" process, you will be able to print or email a Welcome Letter for the customer, which includes login information for the Alarm.com Customer Website.

STEP 3: ENABLE KEYPAD ADDRESS

ENABLING KEYPAD 8 DEVICE ADDRESS 23

The SEM communicates with the VISTA panel as if it is a keypad. By default, the SEM will use **Keypad 8 Device Address 23** to communicate. Address 23 must be enabled via panel programming. To do this, enter programming and select ***196 + [1] + *99** at the keypad.

IF ADDRESS 23 IS ALREADY IN USE

In most cases, Address 23 will be available. If another keypad is already connected to Address 23, you will need to manually select a different keypad address. You can do this by using the DIP switches on the SEM, as pictured below.

1. Identify an available keypad address.
2. Using the chart below, change the DIP switches on the SEM to match the corresponding keypad address.
3. Enable the address by entering the corresponding VISTA programming command at the panel.

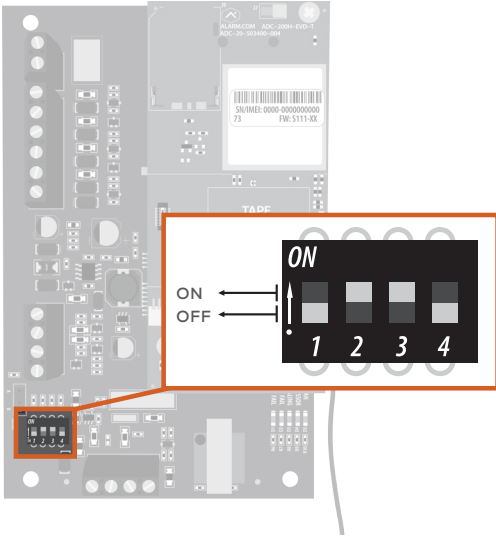

Keypad Address	DIP Switch Setting	VISTA Programming Menu
17	None—all OFF	*190
18	Switch 4 ON, others OFF	*191
19	Switch 3 ON, others OFF	*192
20	Switch 3 and 4 ON, others OFF	*193
21	Switch 2 ON, others OFF	*194
22	Switch 2 and 4 ON, others OFF	*195
23	Switch 2 and 3 ON, others OFF	*196

! *If the correct keypad address is not enabled, repeated reports of Panel Malfunction will be shown in the Event History on the Dealer Website or MobileTech once the SEM is powered on and connects to the network.*

STEP 4: DISCONNECT POWER FROM PANEL

Prior to disconnecting power from the panel, first verify that the panel is disarmed.



Next, remove panel AC Power and disconnect the backup battery.

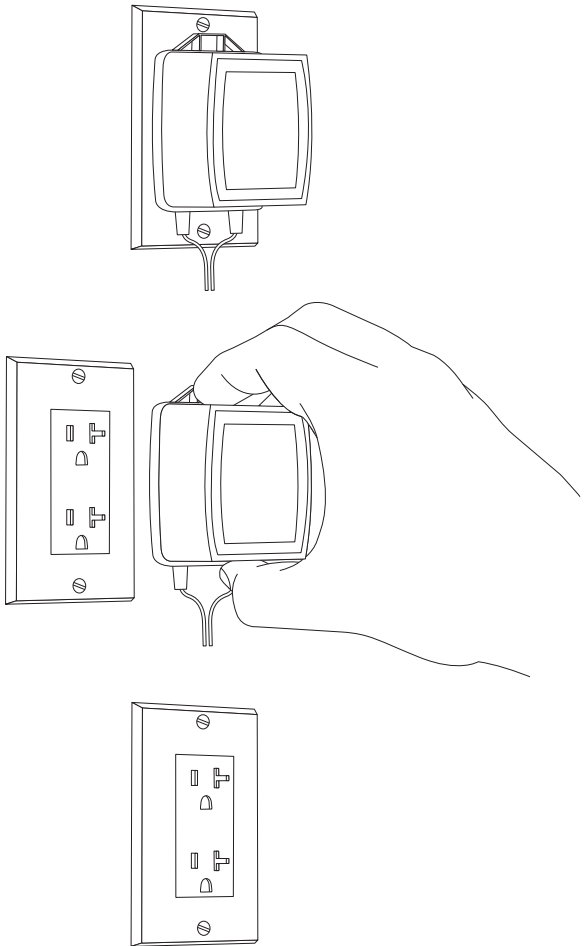

This is necessary to prevent damaging the panel or module while making wiring connections.

STEP 5: MOUNT THE SEM



You must be free of static electricity before handling electronic components. Touch a grounded metal surface before touching the circuit board.

Press down on the bottom tabs of the enclosure cover to remove it and set it aside.

Carefully remove the SEM circuit board by depressing the interior bottom tab.

Place the SEM back plate on the wall at the desired mounting location and mark the three mounting holes as shown below.

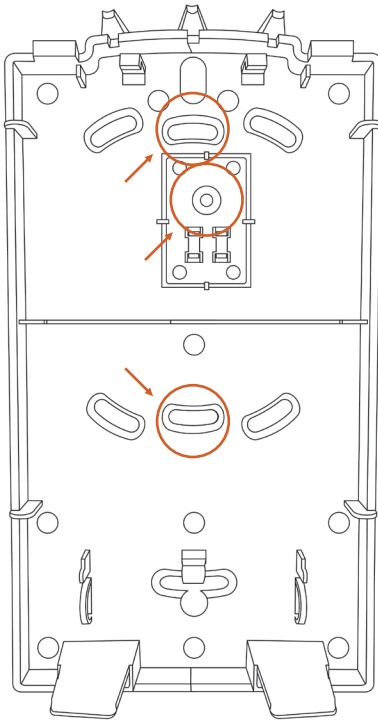

Set the back plate aside and drill holes at the mounting locations.

Use wall anchors where studs are not present and secure the back plate to the wall with the enclosed screws.

Insert the SEM circuit board back into the back plate.

STEP 6: WIRE THE SEM TO THE VISTA PANEL



Verify panel AC Power is removed and the backup battery is disconnected.

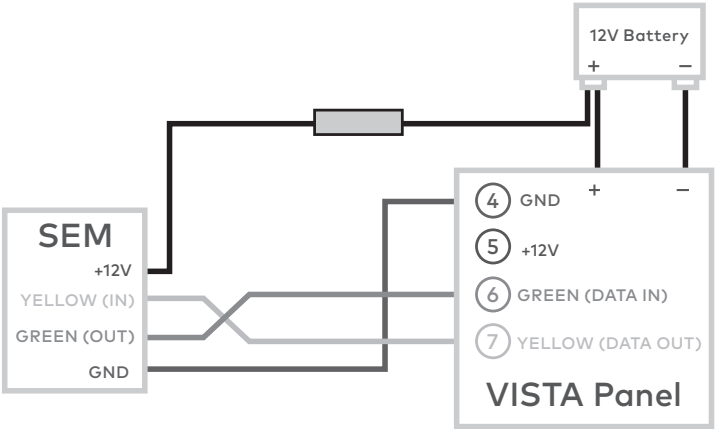

- Connect panel terminal 4 (GND) to SEM GND.
- Connect panel terminal 6 (GREEN: DATA IN FROM KEYPAD) to GREEN (OUT).
- Connect panel terminal 7 (YELLOW: KEYPAD DATA OUT) to YELLOW (IN).
- Use the included red cable with the two prong battery connector to connect the battery to both the SEM and the panel. For a power-limited circuit, ensure the fuse is inside the VISTA panel.

Once wiring is complete, route the antenna(s) outside of the enclosure, away from the SEM, and replace the enclosure cover.

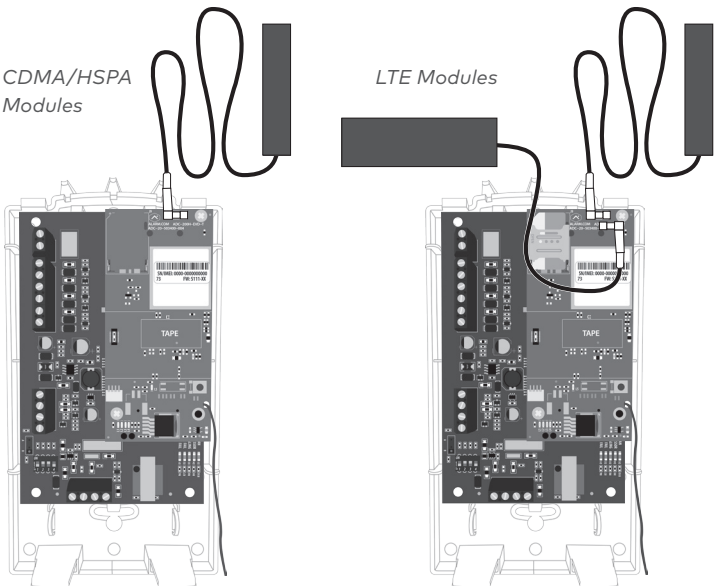

STEP 7: POWER UP THE PANEL

Connect the backup battery and restore AC power to the panel.

For the SEM to interact with the existing zones on the system, it must read them from the VISTA panel. The SEM will do a “zone scan” to read this information.

Additionally, the SEM will automatically set the panel settings needed for the SEM to communicate. These settings can be found on [page 16](#).



ZONE SCAN

~5 minutes

Do not touch the panel or keypad.

The zone scan will automatically begin after the panel is powered up and should take about 5 minutes. **Do not touch the panel, keypad, or SEM at this time.**

The zone scan is complete when the keypad no longer shows the SEM scrolling through the zones and panel settings. During the first three minutes after the zone scan, the SEM will sync the panel settings and equipment list with Alarm.com.



WAIT FOR TEMPORARY MASTER USER CODE TO SYNC

~3 minutes

Do not touch the panel or keypad.

For security purposes, Alarm.com needs to sync the panel with the temporary Master User Code (assigned at account creation in [Step 2](#)). **Do not touch the panel, keypad, or SEM until three minutes after the zone scan is complete.**



CHANGE THE MASTER USER CODE

In most cases, the keypad will beep to signal that the temporary Master User Code is synced. At this time, change the Master User Code at the panel (using the Installer Code). **Do not use a code that has already been saved at the panel.** The SEM will automatically recognize the new code and update it on Alarm.com.

STEP 8: MANAGE USER CODES

Now that the zone scan is complete and the Master User Code has been changed, the Equipment List should be updated on the Dealer Website and the Installer and Master User Codes should be synced with the SEM.

DELETE ALL USER CODES

The SEM is designed to work seamlessly with Alarm.com interactive services, including user code management. However, the SEM cannot read the user codes stored on the panel prior to the SEM being installed.

To enable user code management, all existing user codes must be deleted at the panel and re-entered the first time the user logs in to Alarm.com.

There is a "Delete All User Codes" option available on AirFX and MobileTech.

This **Delete All User Codes** process may take up to 10 minutes, during which time the SEM and panel must not be interrupted. **Do not touch either the SEM or the panel until the process is shown as complete on the Dealer Website or MobileTech Event History, or if there is no activity on the LAN LED for more than one minute.**



Deleting user codes on the VISTA panel will disable keyfobs and remove their user code associations. Keyfobs will need to be re-linked with the new user codes.

ADD & DELETE Z-WAVE DEVICES

Please visit the Dealer Website Support Resources for a complete explanation of Z-Wave communication, Z-Wave signal strength, and additional installation resources.

Alarm.com will not recognize any Z-Wave devices previously learned into the panel. These devices will need to be deleted from the previous Z-Wave network and added to the SEM for the customer to use Alarm.com's home automation services (e.g. automation control via customer website, app, and intelligent automation rules).

TIP:

If the customer is on a different interactive platform, we recommend having them log in to that site and taking screenshots of notifications, rules, and home automation device names for reference later.

For optimal Z-Wave signal strength, make sure the orange Z-Wave antenna is pointed down toward the tabs at the base of the SEM.

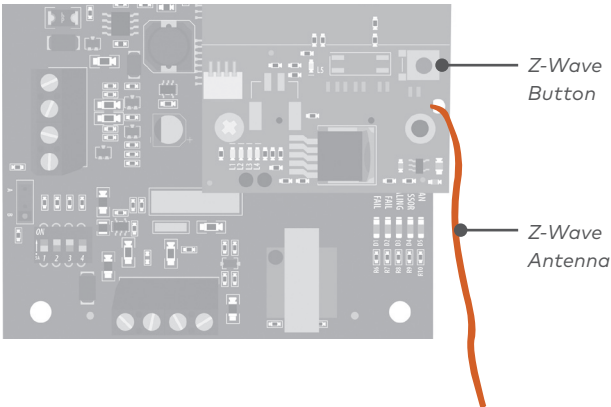

ADDING Z-WAVE DEVICES

Using the Dealer Website or MobileTech is strongly recommended.

Using MobileTech

1. Move all Z-Wave devices to their final location on the property.
2. Open MobileTech and select the customer of interest.
3. Navigate to the Equipment List screen.
4. Select emPower Management.
5. Select Add Z-Wave Devices.
6. Wait for the bolded message: **Checking for new devices on the network.**
7. Trigger a device to add it to the network.
8. When a device is added successfully, it will show up on this screen following a 30 second delay.
9. Continue triggering devices. You may add several devices to the network without re-entering Add Mode.

Using the Dealer Website

1. Move all Z-Wave devices to their final location on the property.
2. Navigate to the Equipment page on the Dealer Website.
3. Click the emPower Devices tab.
4. Open the Advanced Z-Wave Commands menu below the Equipment List.
5. Click Add Z-Wave Devices.
6. Wait for the bolded message: **Checking for new devices on the network.**
7. Trigger a device to add it to the network.
8. When a device is added successfully, it will show up on this screen following a 30 second delay.
9. Continue triggering devices. You may add several devices to the network without re-entering Add Mode.

Using the SEM

1. Press and hold Z-Wave button on the Alarm.com module.
2. Release the button once LED L2 flashes in groups of four.
3. Trigger a device to add it to the network.
4. When a device is added successfully, L2 will illuminate solid.
5. You will need to re-enter Add Mode before triggering the next device.

TIP:

If you can't add a device to the network, you may need to delete the device's current network data using the device deletion process before you can add it to the new network (some devices come from the factory with network data).

DELETING Z-WAVE DEVICES

Using the Dealer Website or MobileTech is strongly recommended.

Using MobileTech

1. Open MobileTech and select the customer of interest.
2. Navigate to the Equipment List screen.
3. Select emPower Management.
4. Select Delete Z-Wave Devices.
5. Wait for the bolded message: **Checking for deleted devices on the network.**
6. Trigger a device to delete it from the network.
7. When a device is deleted successfully and its network data is erased, it will show up on this screen following a 30 second delay.
8. Continue triggering devices. You may delete several devices from the network without re-entering Delete Mode.

Using the Dealer Website

1. Navigate to the Equipment page.
2. Click the emPower Devices tab.
3. Open the Advanced Z-Wave Commands menu below the Equipment List.
4. Click Delete Z-Wave Devices.
5. Wait for the bolded message: **Checking for deleted devices on the network.**
6. Trigger a device to delete it from the network.
7. When a device is deleted successfully and its network data is erased, it will show up on this screen following a 30 second delay.
8. Continue triggering devices. You may delete several devices from the network without reentering Delete Mode.

Using the SEM

1. Press and hold the Z-Wave button on the Alarm.com module.
2. Release the button once LED L2 flashes in groups of four.
3. Press and hold the Z-Wave button on the module a second time.
4. Release the Z-Wave button once LED L2 flashes in groups of two.
5. Trigger a device to erase its network data and delete it from the network.
6. When a device is deleted successfully, L2 will illuminate solid.
7. You will need to re-enter Delete Mode before triggering the next device.

TOUCHSCREEN KEYPADS

The SEM is compatible with AUI devices, including the 6280, Tuxedo Touch, and other touchscreen keypads. Arming, disarming, panics, and alarms initiated on these keypads will be processed by Alarm.com and reported to the central station. However, the following activity will not be processed by Alarm.com unless the keypad is used in Console Mode.

- User code changes
- Changing the Installer Code via Quick Programming mode
- Bypassing open sensors
- The specific user that armed or disarmed the system

Please note that the SEM supports Z-Wave automation via Alarm.com only. This means that customers using the Tuxedo Touch to control their Z-Wave devices will need to choose whether to continue using the Tuxedo Touch for Z-Wave automation, or whether to switch to Alarm.com (e.g. automation control via Customer Website, App, and intelligent automation rules). If the customer chooses to switch to Alarm.com Z-Wave control, then all of the Z-Wave devices will need to be deleted from the Tuxedo Touch and learned into to the SEM.

Even if customers choose not to switch to Alarm.com for Z-Wave automation, they will still be able to enjoy access to video, garage door automation (e.g. Liftmaster), and Lutron lighting control in addition to interactive security via Alarm.com.

PANEL SETTINGS

For the SEM to communicate with the panel and report all alarms, the following VISTA settings need to be set at the panel. These settings are automatically changed during the zone scan so no further action should need to be taken. Here is a list of the automatic programming changes, for reference.

ENABLE IP/GSM

*29 IP/GSM needs to be set to [1]. This will ensure that the panel is communicating with the SEM.

SILENT ALARMS

For the SEM to report silent and duress alarms, the following VISTA settings are automatically changed at the panel.

- *41 Primary Phone No. needs to be cleared.
- *42 Secondary Phone No. needs to be cleared.
- *43 Partition 1 Primary Acct. No. needs to be set to a four-digit number. Alarm.com automatically set this setting to 1234.
- *45 Partition 2 Primary Acct. No. needs to be set to a four-digit number. Alarm.com automatically set this setting to 4321.
- *48 Report Format needs the primary phone number format set to [77].
- *49 Split/Dual Reporting in the VISTA programming needs to be set to [0].
- *54 Dynamic Signaling Delay needs to be set to [0].
- *64 Test Report Code needs to be set to [1,0].
- *92 Phone Line Monitor Enable needs to be set to [0,0].
- The Zone 92 reporting code needs to be enabled for duress reporting.

TIP:

The customer's actual Central Station Forwarding Settings should be setup on the Alarm.com Dealer Website.

BYPASS OPEN SENSORS

Before the customer can use the bypass open sensors feature on the Customer Website or Mobile App, *23 Quick (Forced) Bypass needs to be enabled. This setting is not automatically enabled. If the customer would like to use this feature on the Customer Site or Mobile App, please enable this setting.

LEDs

The Alarm.com Module LEDs can be used to indicate communication errors, panel communication, network communication, and signal strength.

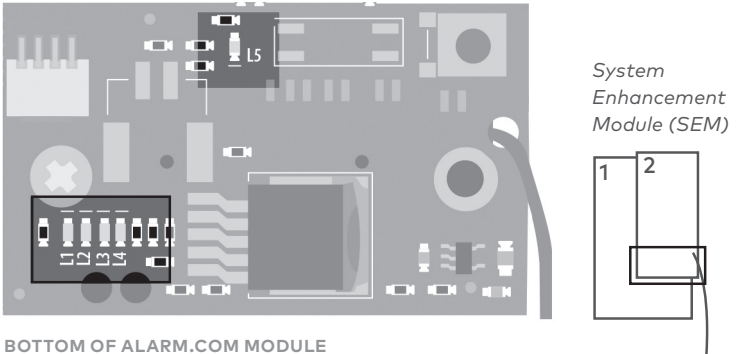

BOTTOM OF ALARM.COM MODULE

LED FUNCTION

- L1** Error LED: L1 will flash 1 to 8 times in a four-second interval to indicate specific error conditions such as a network error, panel communication error, or radio error.
- L2** Panel communication LED: L2 flashes every time a data packet is received from the panel.
- L3** Cellular communication LED: L3 flashes every time a data packet is received from the cellular radio.
- L4** Cellular signal level LED: L4 flashes 0 to 5 times indicating the cellular signal strength, or toggles on/off when communicating with the Alarm.com servers.
- L5** Z-Wave LED: See Home Automation Z-Wave Device Installation on [page 7](#) for more information.

LED L1 (RED)

L1 flashes when an error is encountered. The number of flashes indicates the error number. If there are two or more errors at the same time, the errors will flash one after the other. The LED will stay off for at least four seconds between errors.

NUMBER OF LED L1 ERROR DESCRIPTIONS AND SOLUTION FLASHES

- 1** Alarm.com module cannot communicate with the panel. Perform a power cycle on the panel. If the error persists lift the Alarm.com module out of the SEM circuit board and re-insert it, while power is disconnected from the system.
- 2 then 4** The Alarm.com module provisioning process could not be completed. If the error persists, power cycle the system, then contact Technical Support.
- 2 then 5** The Alarm.com module provisioning process could not be completed because the module is currently roaming off the carrier's primary network.
- 3** The Alarm.com module is trying to register on the cellular network. If it persists for more than a few minutes, the module is having problems registering. Check L4 for signal level. If signal level is lower than 2 bars, change the panel's location or use a remote antenna option.

- 4 The Alarm.com module is registered on the cellular network but could not connect with Alarm.com. Contact Alarm.com Technical Support.
- 5 The radio on the module is not working correctly. If this persists for more than a few minutes the module may need to be replaced. This error is extremely rare, so please verify that the module is flashing 5 times.
- 6 This indicates an error only if it persists for more than a minute. Otherwise, it's an indication that the module is resolving an unusual condition regarding communication with the cellular network.
- 7 The SEM is unable to access panel programming. Check panel wiring and Installer Code.
- 8 If this error persists, the account may have been set up incorrectly. Check that the serial number being used matches the serial number used to create the account on the Dealer Website. If the serial numbers are the same, contact Technical Support.

LED L2 (YELLOW)

L2 flashes with every communication between the SEM and the panel. The normal pattern calls for a series of quick flashes every two seconds when the Alarm.com module is in Idle mode or four seconds in PowerSave mode. See Alarm.com Module States (modes) for an explanation of the three modes.

L2 also occasionally flashes in patterns to indicate Z-Wave status, when the SEM is being used to add or remove Z-Wave devices.

LED L3 (GREEN OR YELLOW)

L3 flashes with every communication between the SEM and its radio unit in Idle mode, and with every communication with Alarm.com in Connected mode. In PowerSave mode, this LED flashes in unison with LED L2.

LED L4 (GREEN OR YELLOW)

L4 indicates the cellular signal level as a number of flashes (0 to 5 bars). The number of bars may not correspond to the number of bars shown on your cell phone. A level of 5 bars is obtained only in the strongest signal conditions. Signal level is updated every ten seconds if it fluctuates, or every 30 seconds if it is fairly stable.

If LED L4 is continuously flashing, the module provisioning process is in progress. LED L4 will begin flashing to indicate signal level as soon as the provisioning process is complete.

If LED L4 is not flashing, this means one of the following:

- The Alarm.com module is in PowerSave mode
- The Alarm.com module just powered up
- There is no cellular coverage in the area

In Connected mode, LED L4 toggles on and off.

TIP: Alarm.com recommends a steady signal level of two or higher for proper operation of the SEM.

LED L5 (YELLOW)

L5 indicates Z-Wave errors. If you can't add a device to the network, try deleting the device and re-adding it to the network. Contact Alarm.com Technical Support with additional issues.

ALARM.COM MODULE STATES (MODES)

There are three Alarm.com module states (modes).

Idle Mode

In Idle mode, the AC power is up, the battery level is greater than 11.5 volts, and the SEM is not currently connected to the Alarm.com servers. This is normal for the SEM and is the most common state.

- L1 Flashes errors, if any
- L2 Communication with panel
- L3 Communication with radio unit
- L4 Signal level (0 to 5 bars)
- L5 Flashes errors, if any

PowerSave Mode

In PowerSave mode, the module just powered up, AC power is down, or battery level is less than 11.5 volts. The radio part of the SEM draws 10 mA in PowerSave mode. It is fully functional and will go into Connected mode as soon as a signal needs to be sent. Performing an Alarm.com phone test will switch the module into Idle mode and update the signal level reading.

- L1 Inactive
- L2 Communication with panel
- L3 Same flashing pattern as L2
- L4 Inactive
- L5 Inactive

Connected Mode

In Connected mode, the SEM is connected to the Alarm.com servers and reported an alarm or other condition. The module stays in Connected mode for at least six minutes after the last message is exchanged. Entering Installer programming will cause the SEM to go into Idle mode.

- L1 Flashes errors, if any
- L2 Communication with panel
- L3 Communication with Alarm.com
- L4 Alternates two seconds on, then two seconds off
- L5 Inactive

FREQUENTLY ASKED QUESTIONS

How should I choose the best location to install the SEM?

- Check the signal strength before choosing a final location. Perform a walking signal strength test by powering the SEM using the battery directly (connect the GND and +12V terminals). After two minutes, cellular signal level LED L4 will flash between one and five times to indicate the signal strength (where five is the strongest signal). Alarm.com recommends a signal level of two or higher for proper operation of the SEM.
- Avoid mounting the SEM in areas with excessive metal or electrical wiring, such as furnace or utility rooms.
- Mount the module near an outside wall, preferably on an upper level.
- Do not mount the SEM inside of the panel's metal box. Doing so will negatively impact Z-Wave performance.
- For homes or businesses located in canyons or with hills nearby, it may be necessary to place the antenna higher in the building.
- If the SEM location requires a longer power cable, splice the provided power wire with the fuse to your wire and leave the fuse inside the VISTA panel enclosure.

Why do I need to enter the Installer Code during account creation?

The Installer Code entered during account creation (see Step 2) will be used to access and read the zones currently learned into the panel. The Installer Code can be changed after the zone scan is complete.

How do I initiate or test communication between the SEM and Alarm.com?

Perform an Alarm.com phone test by pressing [#] + [9] + [8] + [7] + [*]. This phone test will not be viewable on the keypad, but can be verified on the Dealer Website or MobileTech Event History.

Is the SEM compatible with the VISTA-21iP?

The SEM is compatible with the 21iP, if the Internal IP/GSM Jumper is set in the OFF position.

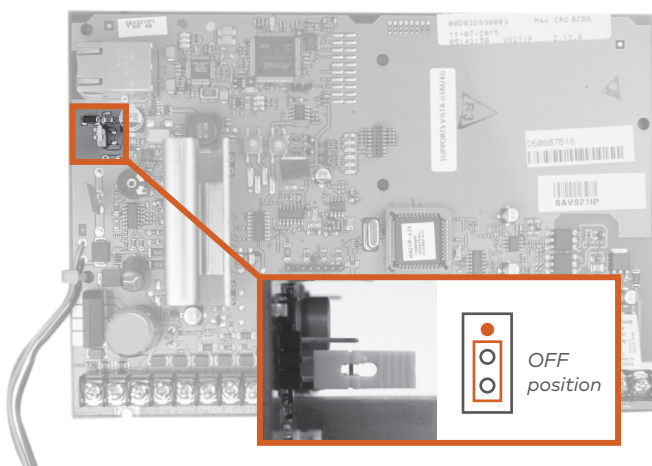

Does the SEM support reporting multiple alarms on a single zone (Swinger Suppression *93)?

The SEM will only report one instance of each alarm per alarm event regardless of the settings specified on the panel in the *93 programming menu. The SEM does not support reporting multiple alarms on a single zone.

Is the SEM compatible with POTS?

No, the SEM should be the only communication path for alarm signaling to the central station.

How does SEM handle dialer delay?

- Default dialer delay for the SEM is 30 seconds regardless of what the panel is set for.
- Changing dialer delay through AirFX will change the setting in the SEM and on the panel.
- Local dialer delay changes will not change the SEM dialer delay.

Is the SEM compatible with Honeywell's Street Smart Series Code Encryptors?

Yes, the SEM is compatible with Honeywell's Street Smart Series Code Encryptors. As with other touchscreen keypads or AUI devices on a system with a Code Encryptor, the following steps will need to be followed to install the SEM.

1. Disconnect power from the panel.
2. Disconnect the touchscreen keypad or AUI device from the panel.
3. Install the SEM, following the SEM installation steps (without the touchscreen keypad or AUI device connected).
4. Once the SEM is installed and working properly, power down the system.
5. Reconnect the touchscreen keypad or AUI device.
6. Restore power to the panel and SEM.

TROUBLESHOOTING

Arming with the Alarm.com App or Customer Website isn't working

If you are unable to arm your system remotely, please change the Master User Code locally to a code of your choosing and then change it back to your desired Master User Code.

The Equipment List is empty on the Dealer Website or MobileTech

If the Equipment List is not showing on the Dealer Website or MobileTech and the SEM failed to do a zone scan when initially powered on, verify that:

- The correct keypad address is enabled
- All wiring is correct
- The Installer Code is synced (if the Installer Code is out of sync you can change it locally at the panel and power cycle)
- The panel is disarmed, and Request an Equipment List on the Dealer Website or power cycle the panel

The SEM is failing to zone scan and the Event History shows several Panel Malfunction error messages

Verify the Keypad Address is enabled correctly. See Step 3.

None of the LEDs on the SEM are ON

Remove power from the panel and verify that all wiring is correct.

SPECIFICATIONS

Compatibility	Honeywell/ADEMCO VISTA-10P, VISTA-15P and VISTA-20P (Please visit alarm.com/dealer for a full list of supported panels and compatibility information)
Power Requirements	12 V nominal, 130 mA (continuous) 2000 mA (instantaneous peaks) maximum (from panel battery)
Cellular Network	Dual Band CDMA (3G), Dual Band HSPA (3G), or Dual Band LTE 3GPP (4G)
Panel Interfaces	One ECP three 2-terminal keypad bus 12V power and ground to panel battery
Alarm.com Module Indicators	One module/panel communication status LED, one module power LED, one automation LED, three wireless communication status LEDs
SEM Circuit Board Indicators	One LAN LED, one processor LED, one COMM fail LED
Operating Temperature	32 to 120°F (0 to 49°C)
Storage Temperature	-30 to 140°F (-34 to 60°C)
Humidity	90% relative humidity non-condensing
Enclosure Dimensions	(L x W x D) 7.5 x 4.25 x 1.5 in. (19.05 x 11.43 x 3.81 cm)
Enclosure Color	White
Case Material	High-impact, ABS plastic
Listings	FCC part 15, Verizon Certified

REGULATORY INFORMATION

Changes or modifications not expressly approved by Alarm.com can void the user's authority to operate the equipment.

This equipment has been tested and found to comply with the limits for a Class B digital device, pursuant to part 15 of the FCC Rules. These limits are designed to provide reasonable protection against harmful interference in a residential installation. This equipment generates, uses, and can radiate radio frequency energy and, if not installed and used in accordance with the instructions, may cause harmful interference to radio communications. However, there is no guarantee that interference will not occur in a particular installation. If this equipment does cause harmful interference to radio or television reception, which can be determined by turning the equipment off and on, the user is encouraged to try to correct the interference by one or more of the following measures:

- Reorient or relocate the receiving antenna.
- Increase the separation between the equipment and receiver.
- Connect the equipment into an outlet on a circuit different from that which the receiver is connected.

Consult the dealer or an experienced radio/TV technician for help. Operation is subject to the following two conditions:

1. This device may not cause interference.
2. This device must accept any interference, including interference that may cause undesired operation of the device.

This equipment complies with the FCC RF radiation exposure limits set forth for an uncontrolled environment. This equipment should be installed and operated with a minimum distance of 20 centimeters between the radiator and your body.

ADC-SEM-100-CDMA

Contains Model:
ADC-200H-EVD

FCC ID:
YL6-143200H5V4;
IC:
9111A-143200H5V4

This device contains Model:
CE910-DUAL

FCC ID:
R17CE910-DUAL;
IC:
5131A-CE910-DUAL

ADC-SEM-100-HSPA

Contains Model:
ADC-200H-EVD

FCC ID:
YL6-143200H5V4;
IC:
9111A-143200H5V4

This device contains Model:
HE910-NAR

FCC ID:
R17HE910NA;
IC:
5131A-HE910NA

ADC-SEM-100-LTE

Contains Model:
ADC-450L

FCC ID:
YL6-143450L;
IC:
9111A-143450L

This device contains Model:
LE910-SVG

FCC ID:
R17LE910SV;
IC:
5131A-LE910SV

SEM QUICK TIPS

S

SET KEYPAD ADDRESS

Ensure the SEM's keypad address is enabled in VISTA programming. The default keypad address is 23 enabled in *196 VISTA programming.

See **Step 3** for additional addresses and their corresponding programming sections.

W

WIRING IS CORRECT

- [PANEL] GREEN DATA IN → [SEM] GREEN (OUT)
- [PANEL] YELLOW DATA OUT → [SEM] YELLOW (IN)
- SEM is powered from 12V battery with included connector and fuse

I

INSTALLER CODE SYNCED WITH SEM

The Installer Code entered during account creation is applied to the SEM during the initialization process. If the system still fails to initiate a zone scan, set the Installer Code to a new value and cycle power.

M

MASTER USER CODE – WAIT TO SYNC BEFORE CHANGING

Do not touch the panel, keypad, or SEM until three minutes after the zone scan is complete. During this time, for security purposes, the SEM will sync the temporary Master User Code that was assigned at account creation. The keypad will normally beep after three minutes to signal that syncing has finished. At this time, **change the Master User Code locally at the panel**. Do not use a code that has already been saved at the panel. The SEM will automatically recognize the new code and update Alarm.com.

Z-WAVE

If the customer has existing Z-Wave devices, they will need to be un-enrolled from the previous controller and re-enrolled in the SEM. Tuxedo Touch users will need to choose between leaving devices enrolled on the Tuxedo for local control or enrolling them on the SEM to enable remote control capability.

CONTACT INFORMATION

If you've completed **SWIM**, but are experiencing difficulties with SEM installation, please contact Alarm.com Technical Support at **866-834-0470** and we'll be happy to assist you further.